

INTERNATIONAL QUALITY STANDARD -  
FULL SYSTEM CUSTOMIZATION

# PRODUCT MANUAL- DOOR AND WINDOWS



## THE PERFECT FIT FOR A LUXURIOUS HOME

Luxury Cabinets and Wardrobes Company Limited specializes in creating high-quality, custom cabinets and wardrobes that combine elegance with functionality. Download our product manual to explore our offerings.

[www.luxfit.ug](http://www.luxfit.ug) ✉ [info@luxfit.ug](mailto:info@luxfit.ug)

# Windows & Doors Series

## Star Series

C-C95 /01  
STAR SERIES C-C95 DOUBLE INTERIOR WINDOW

C-C110 /05  
STAR SERIES C-C110 CASEMENT WINDOW

-C12 /09  
STAR SERIES C-C128SIX TRACK SLIDING WINDOW

C-M95 /13  
STAR SERIES C-M95 CASEMENT DOOR

C-M125/188 /15  
STAR SERIES C-M125/188 SLIDING DOOR

C-M128/189 /19  
STAR SERIES C-M128/189 LIFTING SLIDING DOOR

## Starlight series

G-C60 /21  
STARLIGHT SERIES C-C60 CASEMENT WINDOW

G-C77/118 /25  
STARLIGHT SERIES C-C77/118 SLIDING WINDOW

G-C50 /27  
STARLIGHT SERIES G-C50 CASEMENT WINDOW

G-M77/118 /29  
STARLIGHT SERIES G-M77/118 SLIDING DOOR

G-M70 /31  
STARLIGHT SERIES G-M70 CASEMENT DOOR

## Starbella series

STARBELLA SERIES M-C80 CASEMENT WINDOW

M-C80 33  
STARBELLA SERIES M-M80 SLIDING WINDOW

M-M80 33  
STARBELLA SERIES M-M80 CASEMENT WINDOW

M-M80 33  
STARBELLA SERIES M-M80 CASEMENT WINDOW

M-M80 /33  
STARBELLA SERIES M-M80 SLIDING DOOR

M-C108 /37  
STARBELLA SERIES M-C108 CASEMENT DOOR

M-M150 /37  
STARBELLA SERIES M-M150 CASEMENT DOOR



# Other Series

其他系列

产品目录 CONTENTS

## 幕墙系列 Curtain Wall Series

25系列窄边幕墙 / 39  
25 SERIES NARROW-EDGE  
CURTAIN WALL

## 提升窗系列 Lifting Window Series

T-C128·提升窗 / 41  
T-C128·LIFTING WINDOW

## 阳光房系列 Sunroom Series

全定制阳光房 / 43  
SUNROOM SERIES · FULLY CUSTOMIZED  
SUNROOM

## 护栏系列 Railing Series

室外不锈钢护栏 / 45  
OUTDOOR STAINLESS STEEL GUARDRAIL

室外玻璃护栏 / 46  
OUTDOOR GLASS GUARDRAIL

室外护栏 / 47  
OUTDOOR GUARDRAIL

## 入户门系列 Entrance door series

RFM 系列-入户门 / 49  
RFM Series - Entry Door

## 车库门系列 Garage door series

CKM 系列-车库门 / 49  
CKM Series - Garage Door





门窗系列  
Windows & Doors Series

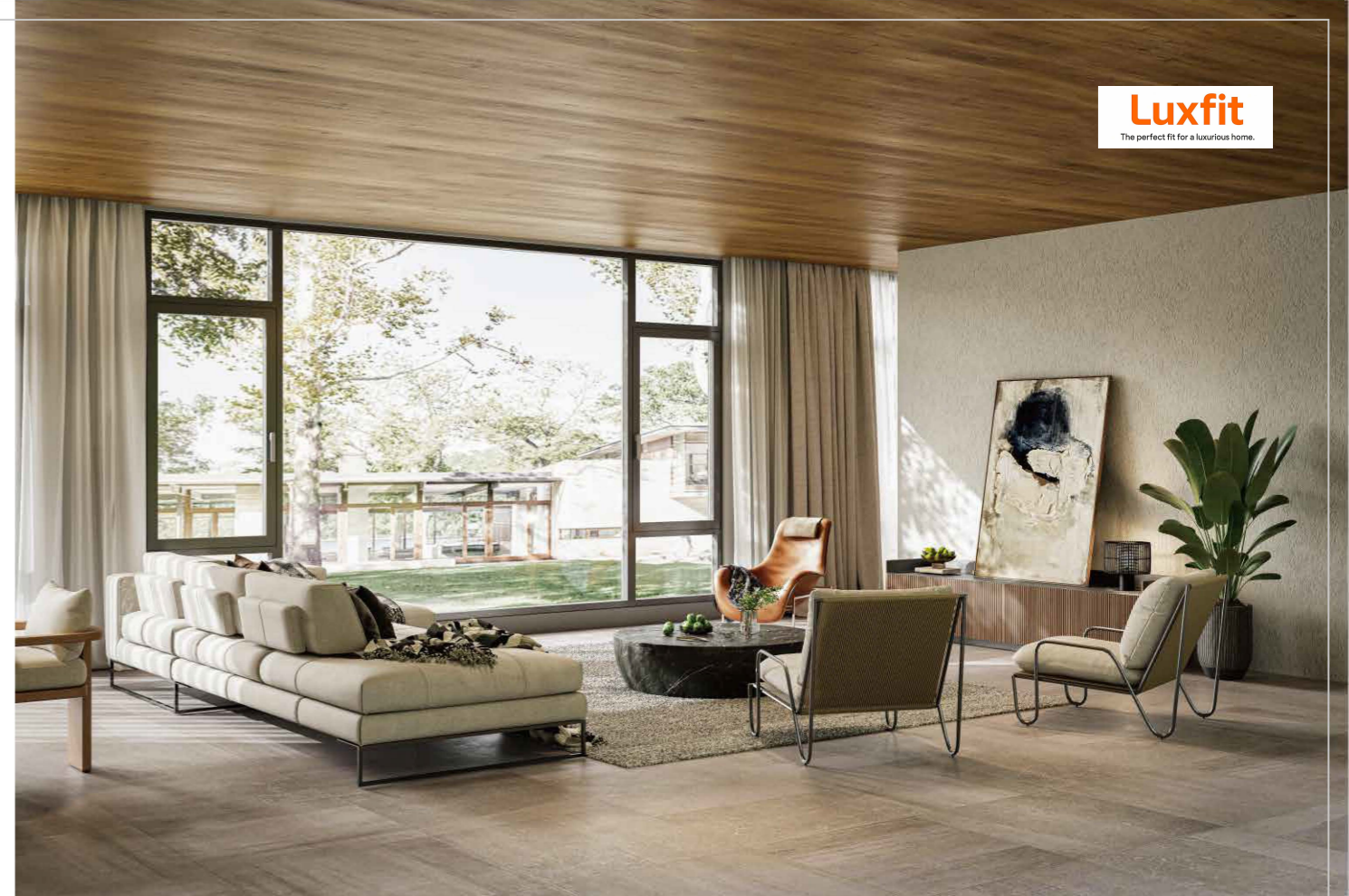

# STAR SERIES

## C-C95 DOUBLE INTERIOR WINDOW 星灿C-C95双内开窗

清风明月在窗前，城市繁华入眼帘，自古以来，人们对美好生活充满无限向往，通过洞察人们的需求，从日月星辰中汲取灵感，以极致性能“窗”造美好空间，打造C-C95系列·内开窗。

The clear breeze and bright moon are in front of the window, and the bustling city catches the eye. Since ancient times, people have been filled with infinite longing for a better life. By understanding people's needs and drawing inspiration from the sun, moon, and stars, they create a beautiful space with the ultimate performance of "windows", and create the C-C95 series · Interior Window.

应用场景：封窗系列（阳台封窗、降噪隔音）

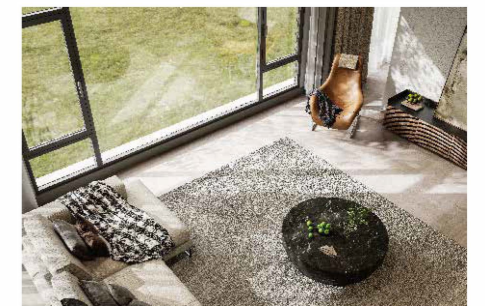

# STAR SERIES

## C-C95 DOUBLE INTERIOR WINDOW

### 星灿C-C95双内开窗

#### 产品外观 / Product appearance

外观 / Appearance: 室内外平框 标配选配 / Optional: 标配纱窗

产品颜色 / Color

常规色



定制色



\*其他颜色自选/Other colors are optional.

#### 产品参数 / Product parameters

型材厚度 / Profile Thickness	6060-T5原生铝 主壁厚2.0mm
框宽 / Box Width	95mm
开启扇扇宽 / Opening Fan Width	500mm-800mm
开启扇扇高 / Opening Fan Height	650mm-1500mm
玻璃配置 / Glass Configuration	5mm+20A+5mm

开启方式 / Opening method

双内开/双内开(玻璃内开内倒)

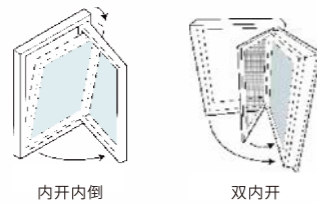

#### 五金配件 / Hardware accessories

五金标配 / Hardware Configuration: 好博无基座执手、平开铰链、定制锁点锁座

#### 产品性能 / Product Performance

水密性能 Water Tightness Performance 600pa-5级	气密性能 Airtightness Performance 1.8m <sup>3</sup> /(m·h)-7级	隔音性能 Sound Insulation Performance 40dB-5级	保温性能 Thermal Insulating Property 1.8W/(m <sup>2</sup> ·K)-7级	抗风压性能 Wind Pressure Resistance Performance 4.8kPa-8级

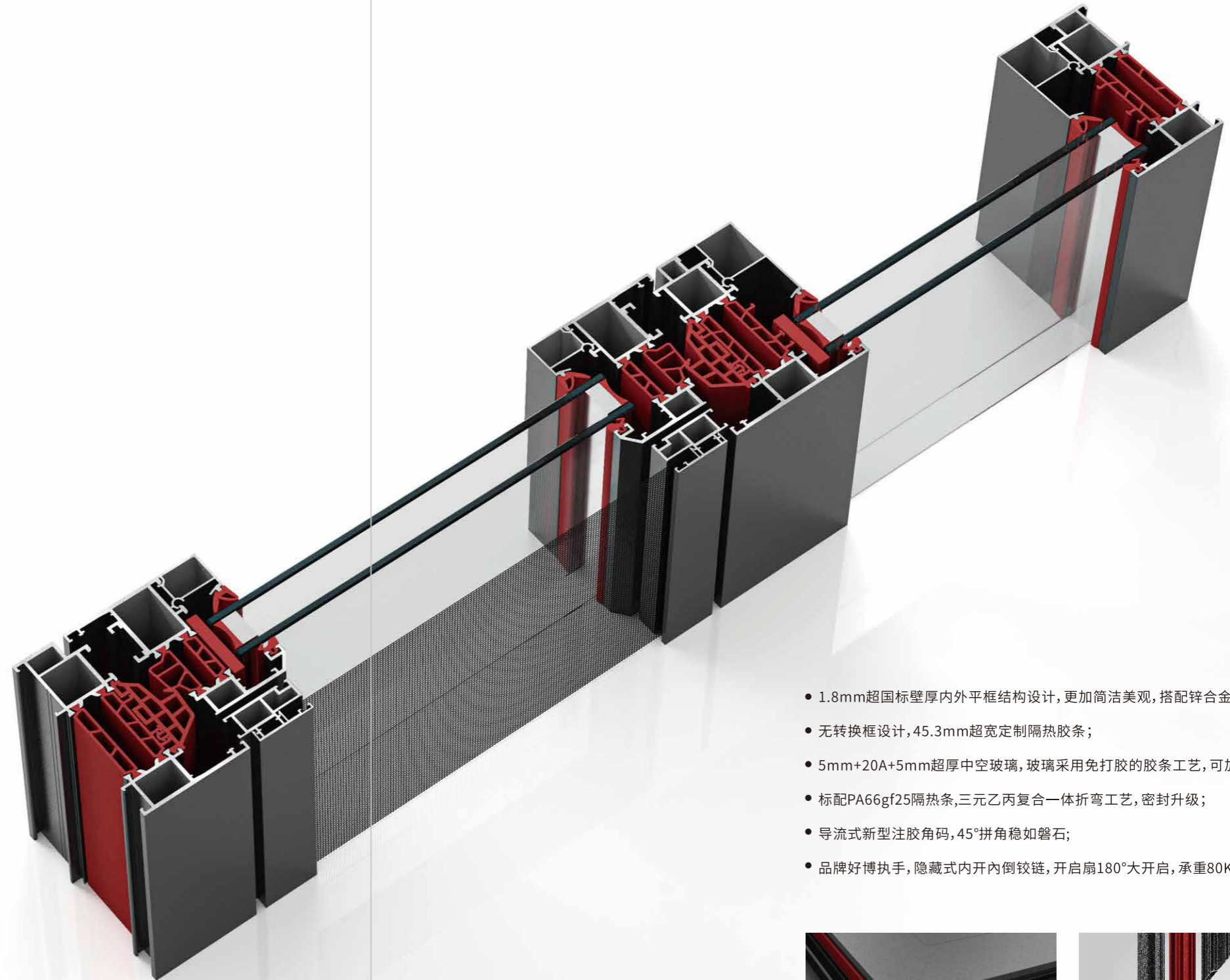

- 1.8mm超国标壁厚内外平框结构设计,更加简洁美观,搭配铝合金防撞护角;
- 无转换框设计,45.3mm超宽定制隔热胶条;
- 5mm+20A+5mm超厚中空玻璃,玻璃采用免打胶的胶条工艺,可加装隔音隔热棉;
- 标配PA66gf25隔热条,三元乙丙复合一体折弯工艺,密封升级;
- 导流式新型注胶角码,45°拼角稳如磐石;
- 品牌好博执手,隐藏式内开内倒铰链,开启扇180°大开启,承重80KG,超承重;

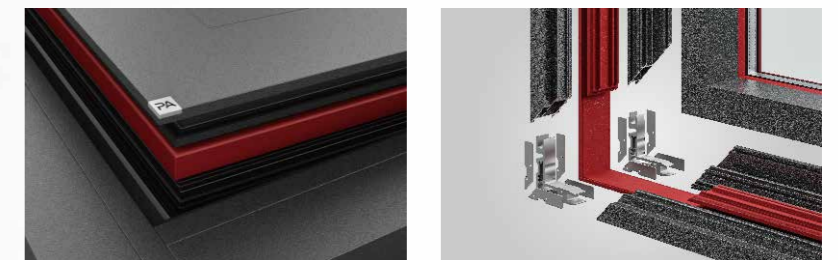

# STAR SERIES



## C-C110 CASEMENT WINDOW 星灿C-C110外开窗

窗景,为万千家庭点缀着美好生活图景,作为美好生活的预见者,不断推进品质门窗的进化与变革,让窗,不仅仅是家与外界的中介,更是一个美好家的“全能守护者”。

Window view embellishes a beautiful life for thousands of families. As a predictor of a better life, we continuously promote the evolution and transformation of quality doors and windows, making them not only the intermediary between home and the outside world, but also the "all-round guardian" of a beautiful home.

应用场景:封窗系列(阳台封窗、降噪隔音)

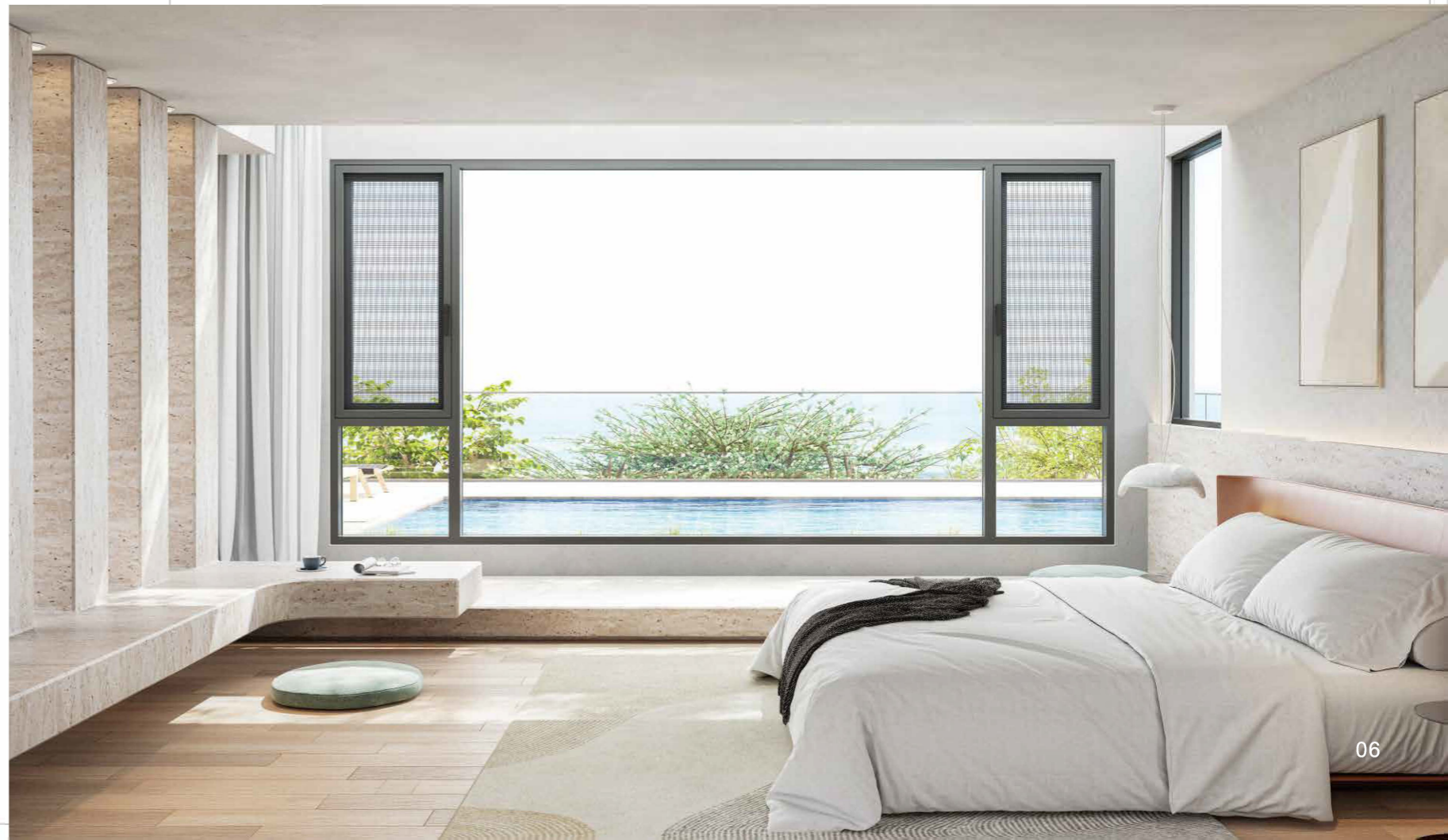

# STAR SERIES

## C-C110 CASEMENT WINDOW

### 星灿C-C110外开窗

#### 产品外观 / Product appearance

外观 / Appearance: 室内外平框 标配选配 / Optional: 标配带纱/可选配防盗栏

产品颜色 / Color

常规色

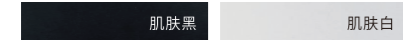

定制色



\*其他颜色自选/Other colors are optional.

#### 产品参数 / Product parameters

型材厚度 / Profile Thickness	6060-T5原生铝 主壁厚2.0mm
框宽 / Box Width	110mm
开启扇扇宽 / Opening Fan Width	510mm-800mm
开启扇扇高 / Opening Fan Height	680mm-1800mm
玻璃配置 / Glass Configuration	5mm+20A+5mm

开启方式 / Opening method

外平开/上悬/外开上悬

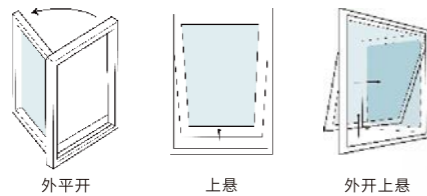

#### 五金配件 / Hardware accessories

五金标配 / Hardware Configuration: 好博无基座执手、平开铰链、定制锁点锁座

#### 产品性能 / Product Performance

 水密性能 Water Tightness Performance 700pa-6级	 气密性能 Airtightness Performance 1.5m <sup>3</sup> /(m·h)-8级	 隔音性能 Sound Insulation Performance 40dB-5级	 保温性能 Thermal Insulating Property 1.8W/(m <sup>2</sup> ·K)-7级	 抗风压性能 Wind Pressure Resistance Performance 5.0kPa-9级
---	---	---	--	--

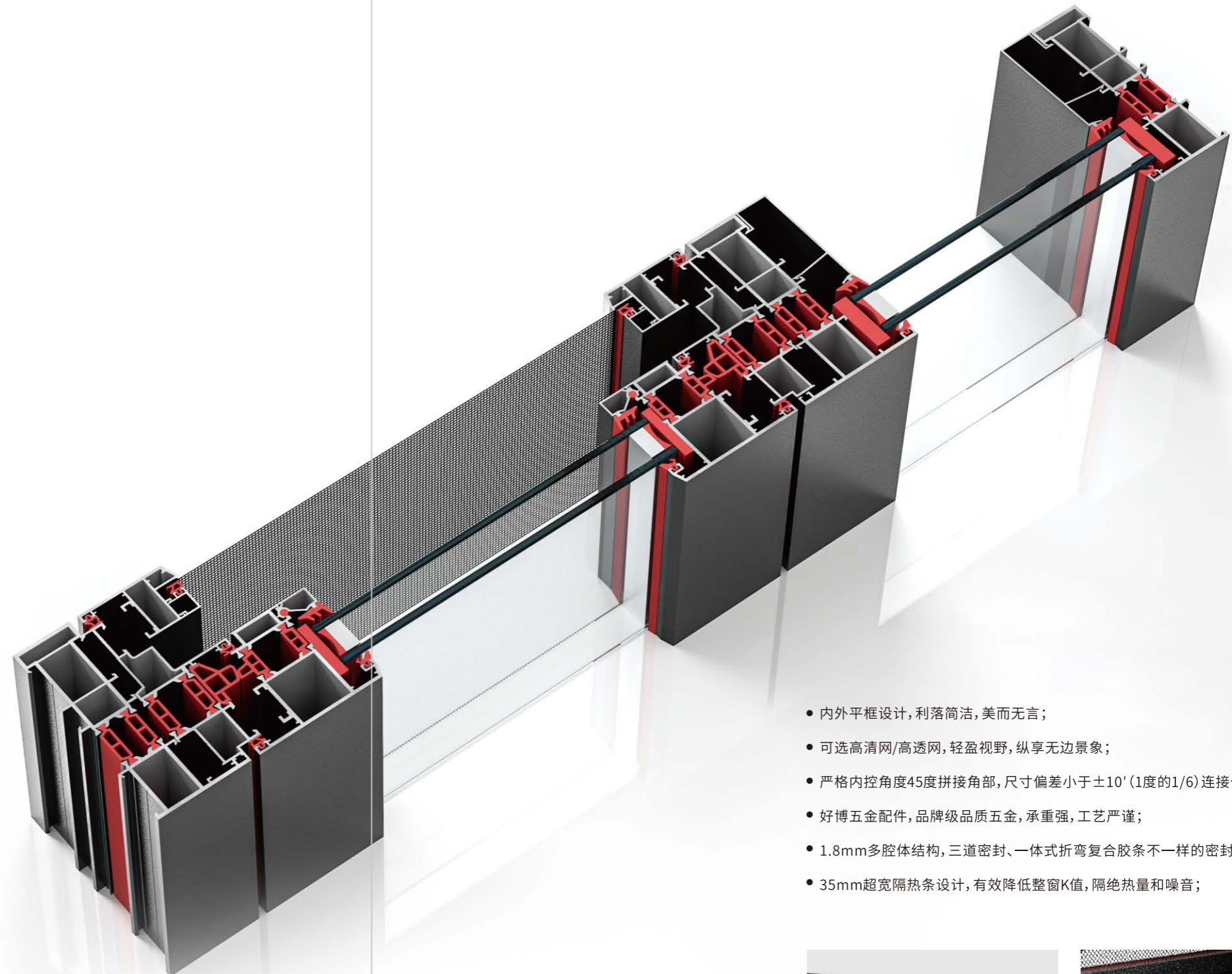

- 内外平框设计, 利落简洁, 美而无言;
- 可选高清网/高透网, 轻盈视野, 纵享无边景象;
- 严格内控角度45度拼接角部, 尺寸偏差小于±10' (1度的1/6) 连接位更贴合
- 好博五金配件, 品牌级品质五金, 承重强, 工艺严谨;
- 1.8mm多腔体结构, 三道密封、一体式折弯复合胶条不一样的密封力;
- 35mm超宽隔热条设计, 有效降低整窗K值, 隔绝热量和噪音;

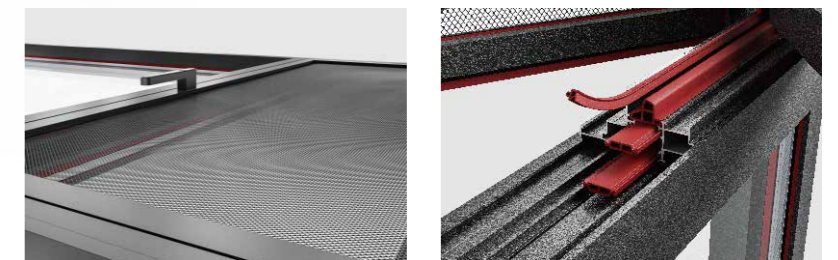

# STAR SERIES

## C-C128 SIX TRACK SLIDING WINDOW



### 星灿C-C128六轨推拉窗

安全门窗的另一种形态，断桥推拉窗，匠心雕琢，刷新推拉窄边之美，安全推拉，保证大单扇观景无忧。

Another form of safety doors and windows, the broken bridge sliding window, is meticulously crafted to refresh the beauty of narrow edges, ensuring a safe sliding and comfortable viewing of large single windows.

应用场景：封窗系列（阳台封窗、降噪隔音）

# STAR SERIES

## C-C128 SIX TRACK SLIDING WINDOW

### 星灿C-C128六轨推拉窗

#### 产品外观 / Product appearance

外观 / Appearance: 扇料可视面宽度30mm 标配选配 / Optional: 标配纱扇

#### 产品颜色 / Color

常规色



定制色



\*其他颜色自选/Other colors are optional.

#### 产品参数 / Product parameters

型材厚度 / Profile Thickness	6060-T5原生铝 下滑主壁厚2.9mm/扇料1.8mm
框宽 / Box Width	128mm
单扇扇宽 / Single Fan Width	600mm-1500mm(单扇面积不大于3.5m <sup>2</sup> )
单扇扇高 / Single Fan Height	600mm-2000mm
玻璃配置 / Glass Configuration	5mm+15A+5mm

#### 五金配件 / Hardware accessories

五金标配 / Hardware Configuration: 宝高隐藏式自动碰锁

#### 产品性能 / Product Performance

				
水密性能 Water Tightness Performance 400pa-4级	气密性能 Airtightness Performance 4.8m <sup>3</sup> /(m·h)-5级	隔音性能 Sound Insulation Performance 35dB-4级	保温性能 Thermal Insulating Property 2.5W/(m <sup>2</sup> ·K)-5级	抗风压性能 Wind Pressure Resistance Performance 4.3kPa-7级



- 六轨带纱推拉窗,也可不带纱
- 单扇可做3.45个平方,不占室内空间,大通风、大视野
- 自动隐藏式碰锁,正视图看不到五金,简美悦目
- 精密断桥内部结构,阻断窗体内部冷热能传递室内温度更稳定,节能低碳又环保
- 上轨防盗胶块,台风天不移位,防窗扇掉落。下轨防水胶块,加快排水,暴雨天护家无忧。
- 琥珀防台风防摆轮,杜绝窗扇因极端天气影响而坠落,琥珀静音滑轮,推拉静音顺滑,耐磨耐候

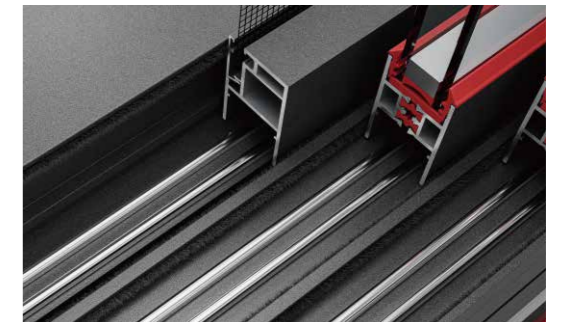



**C-M95 CASEMENT DOOR**

星灿C-M95平开门

STAR SERIES



**产品外观 / Product appearance**

外观 / Appearance : 扇料可视面宽度40mm

标配选配 / Optional :

产品颜色 / Color

外开/内开/选配纱扇/高低轨/法式

常规色



定制色



\*其他颜色自选/Other colors are optional.

**产品参数 / Product parameters**

型材厚度 / Profile Thickness	6060-T5原生铝 壁厚2.0mm
框宽 / Box Width	95mm
单扇扇宽 / Single Fan Width	400mm-1200mm(单扇面积不大于2.5m <sup>2</sup> )
单扇扇高 / Single Fan Height	1600mm-3000mm
玻璃配置 / Glass Configuration	5mm+27A+5mm

**五金配件 / Hardware accessories**

五金标配 / Hardware Configuration : 好博执手, 好博合页, 好博插销锁座

**产品性能 / Product Performance**



水密性能  
Water Tightness  
Performance  
600pa-5级



气密性能  
Airtightness  
Performance  
1.8m<sup>3</sup>/(m<sup>2</sup>·h)-7级



隔音性能  
Sound Insulation  
Performance  
40dB-5级



保温性能  
Thermal Insulating  
Property  
1.8W/(m<sup>2</sup>·K)-7级



抗风压性能  
Wind Pressure Resistance  
Performance  
4.8kPa-8级

# STAR SERIES



## C-C128 SIX TRACK SLIDING WINDOW 星灿C-M125/188推拉门

在北欧城市莱顿，优雅古老的大学建筑，独特的风车和吊桥，尽显时光沉淀后的优雅，致敬经典人文杰作，汲取莱顿文化内核，打造气派非凡家居美学。

In the Nordic city of Leiden, the elegant and ancient university buildings, unique windmills and suspension bridges showcase the elegance of time, pay tribute to classic cultural masterpieces, and draw on the core of Leiden culture to create a magnificent and extraordinary home aesthetics

应用场景：室外隔断(阳台、庭院)



# STAR SERIES

## C-C125 SIX TRACK SLIDING WINDOW

### 星灿C-M125/188推拉门

#### 产品外观 / Product appearance

外观 / Appearance: 极窄隐藏式边框 标配选配 / Optional: 选配纱扇, 选配三轨道, 选配无立柱转角

产品颜色 / Color

常规色

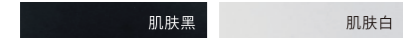

定制色



\*其他颜色自选/Other colors are optional.

#### 产品参数 / Product parameters

型材厚度 / Profile Thickness	6060-T5原生铝 壁厚2.0mm, 框厚2.1mm, 主型材3.0mm
框宽 / Box Width	125/188mm
开启扇扇宽 / Opening Fan Width	600mm-1500mm
开启扇扇高 / Opening Fan Height	1600mm-3000mm
玻璃配置 / Glass Configuration	5mm+20A+5mm
开启方式 / Opening method	推拉

#### 五金配件 / Hardware accessories

五金标配 / Hardware Configuration: 宝高防护操作锁 (可选配带钥匙)

#### 产品性能 / Product Performance



水密性能  
Water Tightness  
Performance  
450pa-4级



气密性能  
Airtightness  
Performance  
4.8m<sup>3</sup>/(m·h)-5级



隔音性能  
Sound Insulation  
Performance  
35dB-4级



保温性能  
Thermal Insulating  
Property  
2.3W/(m<sup>2</sup>·K)-6级



抗风压性能  
Wind Pressure Resistance  
Performance  
5.0kPa-9级

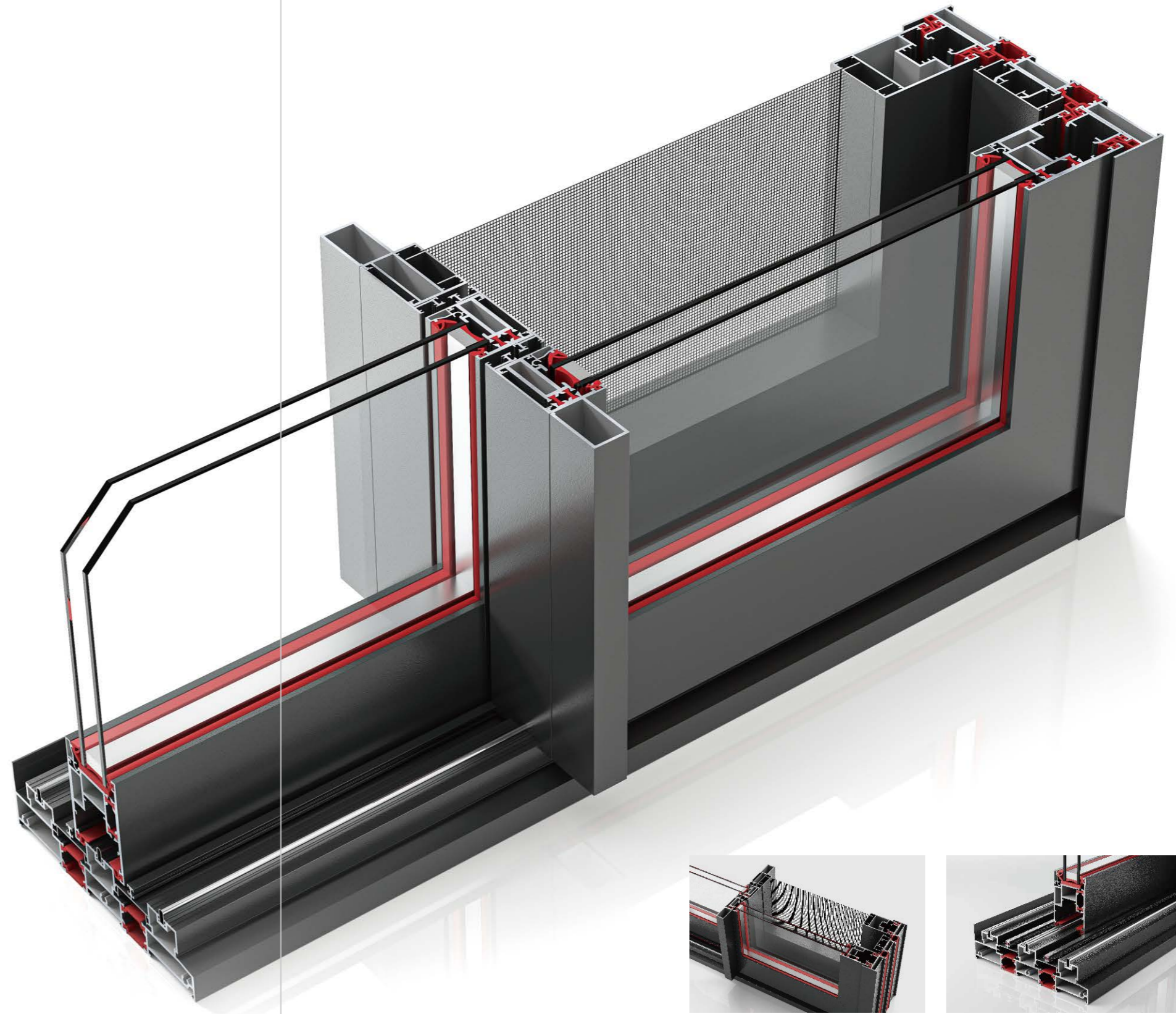

# STAR SERIES



## C-M128/189 LIFTING SLIDING DOOR 星灿C-M128/189提升推拉门

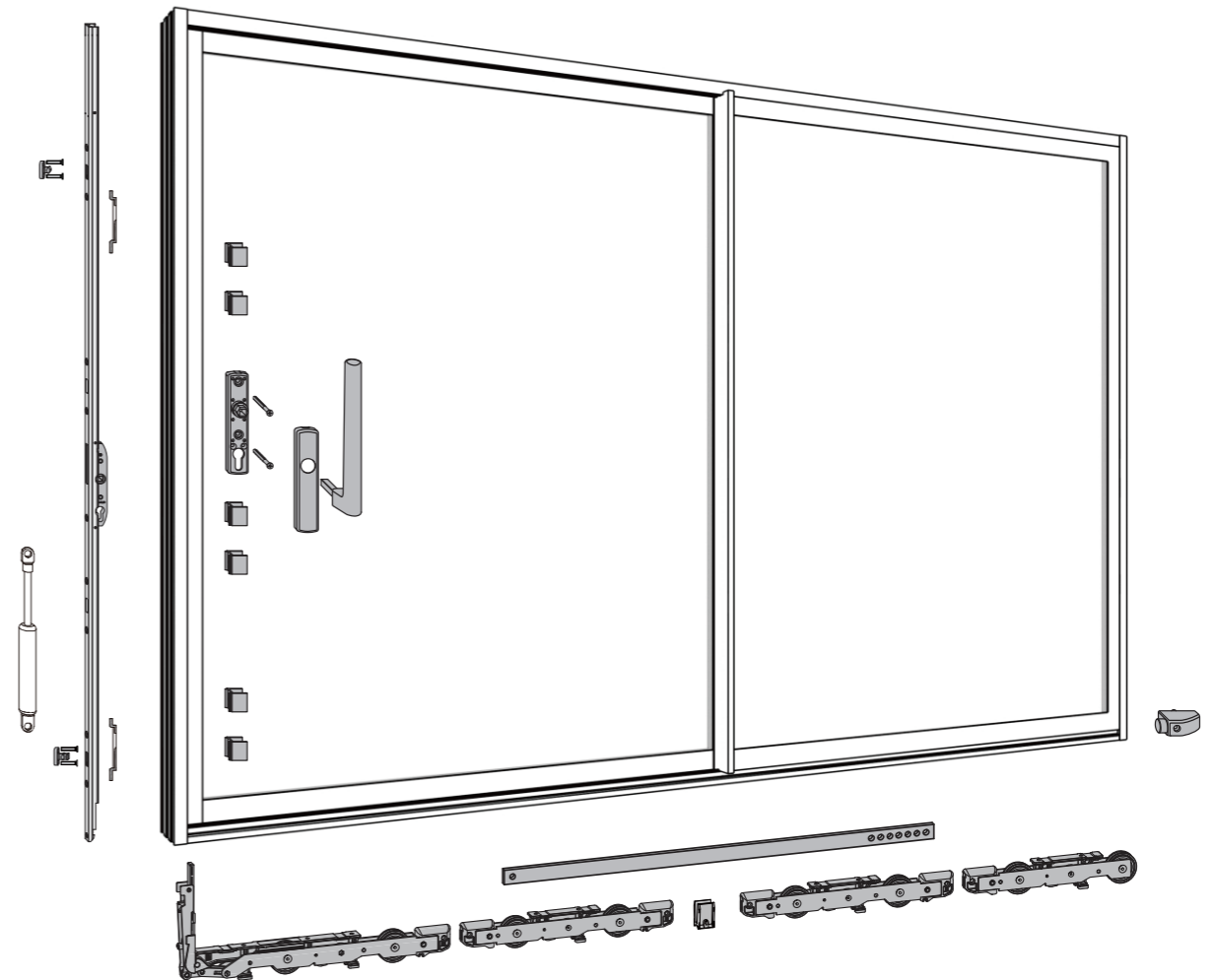

### 产品外观 / Product appearance

外观 / Appearance: 极窄隐藏式边框 标配选配 / Optional: 标配宝高一字锁 / 可选配重型提升系统

### 产品颜色 / Color

常规色

肌肤黑

肌肤白

定制色

哑光银灰

砂纹黑

砂纹灰

香槟金

\*其他颜色自选 / Other colors are optional.

### 产品参数 / Product parameters

型材厚度 / Profile Thickness	6060-T5原生铝 扇壁厚3.0mm 框壁厚2.2mm
框宽 / Box Width	128mm
单扇扇宽 / Single Fan Width	600mm-1500mm(单扇面积不大于4.8m <sup>2</sup> )
单扇扇高 / Single Fan Height	1600mm-3000mm
玻璃配置 / Glass Configuration	标配5mm+22A+5mm双层钢化玻璃

### 五金配件 / Hardware accessories

五金标配 / Hardware Configuration: 标配宝高/选配德国丝吉利娅重型提升系统 / 承量200-400kg

### 产品性能 / Product Performance



水密性能  
Water Tightness  
Performance  
450pa-4级



气密性能  
Airtightness  
Performance  
4.8m<sup>3</sup> / (m·h) -5级



隔音性能  
Sound Insulation  
Performance  
35dB-4级



保温性能  
Thermal Insulating  
Property  
2.3W / (m<sup>2</sup>·K) -6级



抗风压性能  
Wind Pressure Resistance  
Performance  
5.0kPa- 9级

## C-C60 CASEMENT WINDOW

### 星光G-C60平开窗

斜顶空间遇上平开窗，一方框景，将四季天光与葱郁景致尽收。极简线条勾勒通透质感，静享惬意慵懒的卧室日常。

When the slanted roof space meets the casement window, a square frame captures the seasonal skylight and lush scenery in its entirety. Minimalist lines outline a transparent texture, allowing one to enjoy the cozy and lazy daily life in the bedroom.

应用场景：封窗系列（阳台封窗、降噪隔音）

# STARLIGHT SERIES



# STARLIGHT SERIES

## C-C60 CASEMENT WINDOW

### 星光G-C60平开窗

#### 产品外观 / Product appearance

外观 / Appearance: 室内外平框

产品颜色 / Color

常规色

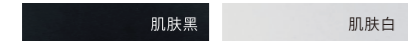

定制色



\*其他颜色自选/Other colors are optional.

#### 产品参数 / Product parameters

型材厚度 / Profile Thickness	6060-T5原生铝 壁厚1.4mm
框宽 / Box Width	60mm
开启扇扇宽 / Opening Fan Width	500mm-800mm
开启扇扇高 / Opening Fan Height	600mm-1800mm
玻璃配置 / Glass Configuration	5mm+9A+5mm

#### 开启方式 / Opening method

外平开 / 上悬 / 外开上悬 / 内开/双内开 / 内开内倒

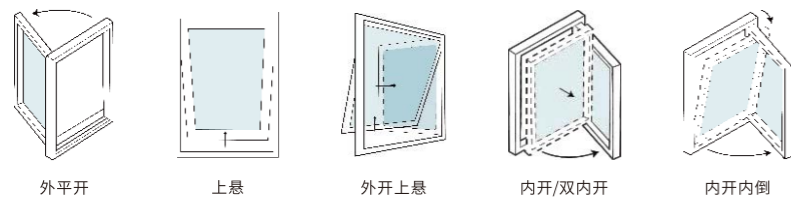

#### 五金配件 / Hardware accessories

五金标配 / Hardware Configuration: 好博五金

#### 产品性能 / Product Performance

				
水密性能 Water Tightness Performance 600pa-5级	气密性能 Airtightness Performance 1.8m <sup>3</sup> /(m·h)-7级	隔音性能 Sound Insulation Performance 40dB-5级	保温性能 Thermal Insulating Property 1.8W/(m <sup>2</sup> ·K)-7级	抗风压性能 Wind Pressure Resistance Performance 4.5kPa-8级

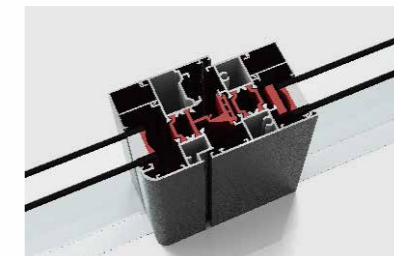
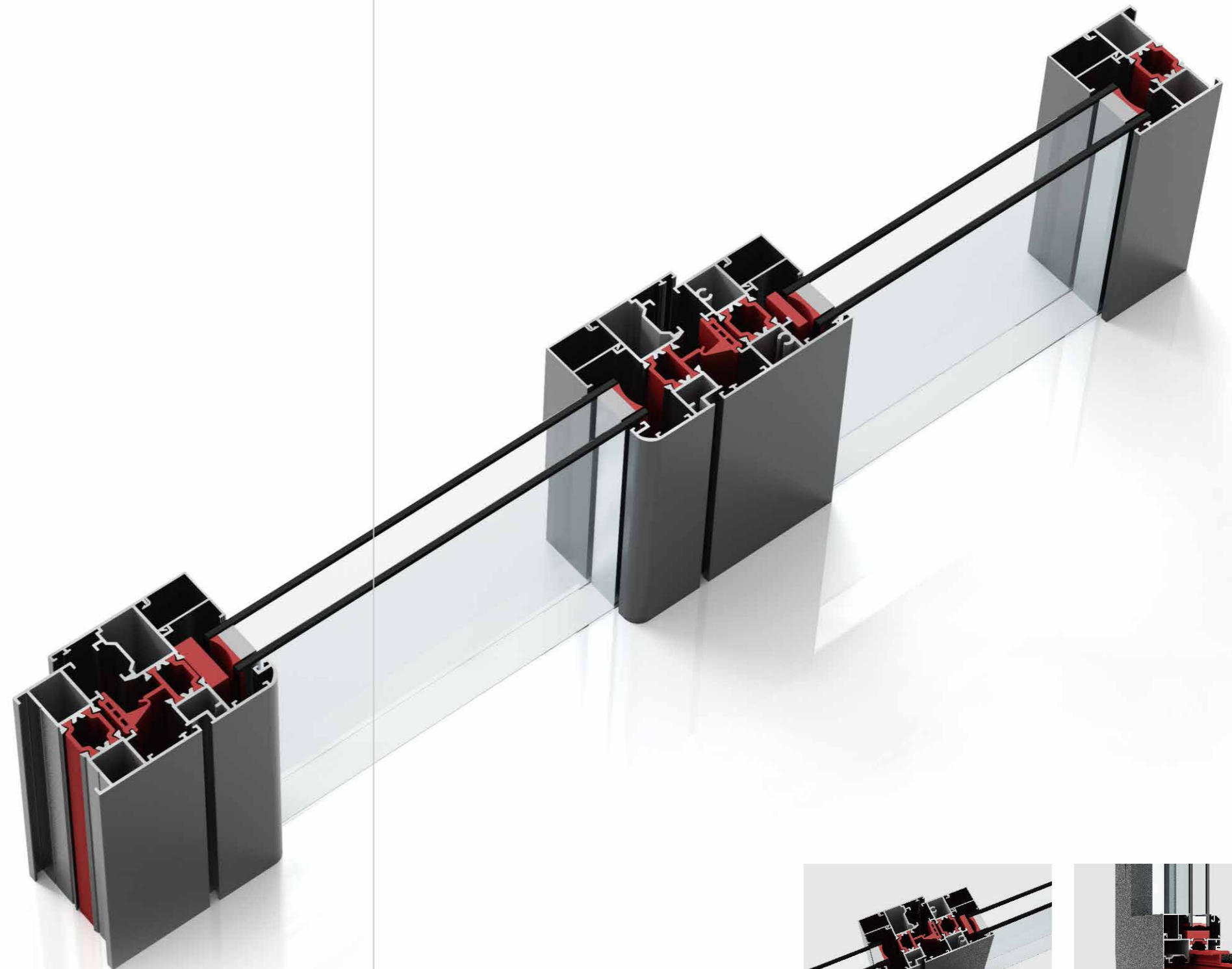



## C-C77/118 · SLIDING WINDOW 星光G-C77/118 · 推拉窗

### 产品外观 / Product appearance

外观 / Appearance : 扇料可视面宽度 70mm

产品颜色 / Color

常规色



定制色



\*其他颜色自选/Other colors are optional.

### 产品参数 / Product parameters

型材厚度 / Profile Thickness	6060-T5原生铝,下轨道1.4mm,扇料1.4mm
框宽 / Box Width	77mm/118mm
开启扇扇宽 / Opening Fan Width	600mm-1100mm
开启扇扇高 / Opening Fan Height	600mm-2200mm
玻璃配置 / Glass Configuration	5mm+12A+5mm
开启方式 / Opening method	两轨/三轨

### 五金配件 / Hardware accessories

五金标配 / Hardware Configuration : 宝高推拉五金/定制双点锁

### 产品性能 / Product Performance



水密性能  
Water Tightness  
Performance  
350pa-4级



气密性能  
Airtightness  
Performance  
4.8m<sup>3</sup>/(m·h)-5级



隔音性能  
Sound Insulation  
Performance  
35dB-4级



保温性能  
Thermal Insulating  
Property  
2.5W/(m<sup>2</sup>·K)-5级



抗风压性能  
Wind Pressure Resistance  
Performance  
4.3kPa-7级

# STARLIGHT SERIES

# STARLIGHT SERIES



## G-C50 · CASEMENT WINDOW 星光G-C50·平开窗

### 产品外观 / Product appearance

外观 / Appearance: 平整铝框

产品颜色 / Color

常规色



定制色



\*其他颜色自选/Other colors are optional.

### 产品参数 / Product parameters

型材厚度 / Profile Thickness	壁厚1.3mm, 加强中挺壁厚1.4mm
框宽 / Box Width	50mm
单扇扇宽 / Single Fan Width	500mm-800mm(单扇面积不大于1m²)
单扇扇高 / Opening Fan Height	600mm-1800mm
玻璃配置 / Glass Configuration	单玻6mm
玻璃装配 / Glass Installation	玻璃胶固定

### 五金配件 / Hardware accessories

五金标配 / Hardware Configuration: 品爱定制五金

### 产品性能 / Product Performance



水密性能  
Water Tightness  
Performance  
500pa-5级



气密性能  
Airtightness  
Performance  
1.8m³/(m·h)-7级



隔音性能  
Sound Insulation  
Performance  
40dB-5级



保温性能  
Thermal Insulating  
Property  
2.0W/(m²·K)-6级



抗风压性能  
Wind Pressure Resistance  
Performance  
4.3kPa-7级





## G-M77/118 · SLIDING DOOR 星光G-M77/118·推拉门

### 产品外观 / Product appearance

外观 / Appearance: 室内外平框 标配选配 / Optional: 标配纱窗/可选配防盗栏

产品颜色 / Color

常规色

肌肤黑

肌肤白

定制色

哑光银灰

砂纹黑

砂纹灰

香槟金

\*其他颜色自选/Other colors are optional.

### 产品参数 / Product parameters

型材厚度 / Profile Thickness	6060-T5原生铝 壁厚1.4mm
框宽 / Box Width	77mm/118mm
开启扇扇宽 / Opening Fan Width	600mm-1100mm
开启扇扇高 / Opening Fan Height	1600mm-2200mm
玻璃配置 / Glass Configuration	5mm+12A+5mm
开启方式 / Opening method	两轨推拉/三轨推拉

### 五金配件 / Hardware accessories

五金标配 / Hardware Configuration: 宝高推拉五金 (可选配拉手)

### 产品性能 / Product Performance



水密性能  
Water Tightness  
Performance  
350pa-4级



气密性能  
Airtightness  
Performance  
4.8m³ / (m·h)-5级



隔音性能  
Sound Insulation  
Performance  
35dB-4级



保温性能  
Thermal Insulating  
Property  
2.5W / (m²·K)-5级



抗风压性能  
Wind Pressure Resistance  
Performance  
4.3kPa-7级



STARLIGHT SERIES

# STARLIGHT SERIES

## G-M70 · CASEMENT DOOR 星光G-M70·平开门

### 产品外观 / Product appearance

外观 / Appearance: 常规平开门边框 标配选配 / Optional: 选配纱扇 / 选配内置百叶 / 法式

产品颜色 / Color

常规色



定制色



\*其他颜色自选 / Other colors are optional.

### 产品参数 / Product parameters

型材厚度 / Profile Thickness	6060-T5原生铝 主壁厚2.0mm
框宽 / Box Width	70mm
单扇扇宽 / Single Fan Width	1000mm (单扇面积不大于2.5m <sup>2</sup> )
单扇扇高 / Opening Fan Height	2500mm
玻璃配置 / Glass Configuration	5mm+27A+5mm
开启方式 / Opening method	外开 / 内开 / 对开

### 五金配件 / Hardware accessories

五金标配 / Hardware Configuration: 好博执手, 好博合页, 好博插锁座 (可选希美克)

### 产品性能 / Product Performance



水密性能  
Water Tightness  
Performance  
600pa-5级



气密性能  
Airtightness  
Performance  
1.8m<sup>3</sup> / (m · h) -7级



隔音性能  
Sound Insulation  
Performance  
40dB-5级



保温性能  
Thermal Insulating  
Property  
1.8W / (m<sup>2</sup> · K) -7级



抗风压性能  
Wind Pressure Resistance  
Performance  
4.8kPa -8级

M-M80

M-C80

M-M80

M-M80

STARBELLA SERIES

# STARBELLA SERIES

# STARBELLA SERIES

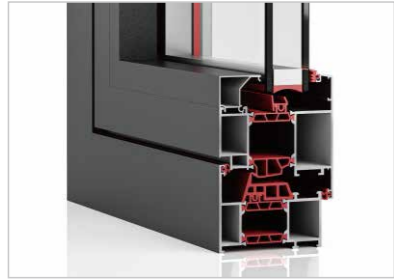

星美M-C80平开窗  
STARBELLA SERIES M-M80 SLIDING WINDOW

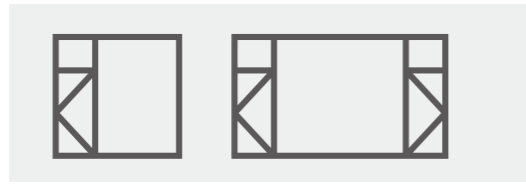

星美M-M80平开门  
STARBELLA SERIES M-M80 CASEMENT WINDOW

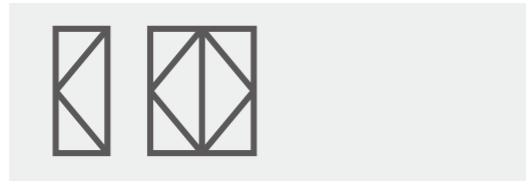

星美M-M80折叠门  
STARBELLA SERIES M-M80 CASEMENT WINDOW

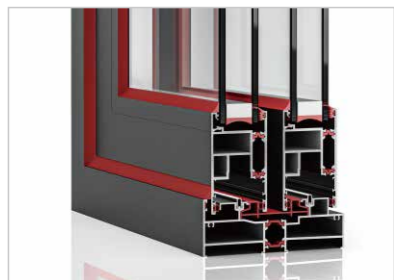
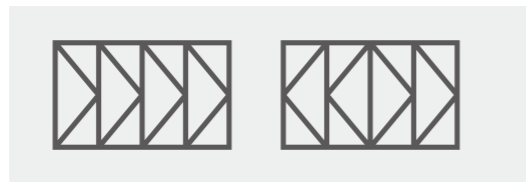

星美M-M80推拉门  
STARBELLA SERIES M-M80 SLIDING DOOR

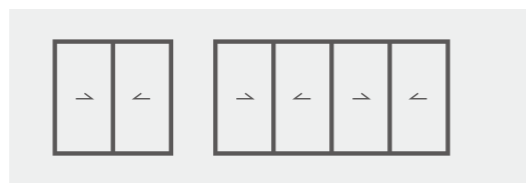

# STARBELLA SERIES



**M-C108 CASEMENT DOOR**  
星美M-C108平开窗



**M-M150 CASEMENT DOOR**  
星美M-M150推拉门

# 25 SERIES NARROW-EDGE CURTAIN WALL

## 25系列窄边幕墙



### 产品性能 / Product Performance Introduction

- 边框规格138\*40mm,采用3.0mm壁厚,超高强度满足大玻璃强度需求;
- 窄框视面,可以最大面积地将阳光引进室内,打造敞亮、舒适的室内环境,拥抱阳光生活;
- 窗扇多种开启形式,可配置纱窗,保持通风透气又可防止蚊虫进入室内,满足不同使用需求;
- 外立面平整,线条流畅,极窄边框,不仅能提升建筑的观赏性,还使建筑显得更有格调,彰显出主人品味。

### 产品参数 / Product parameters

型材厚度 / Profile Thickness	立柱3.0mm/平开窗1.8mm
立柱规格 / Column specifications	138mmX40mm
装饰盖板规格 / Specification of decorative cover plate	21mmX40mm
玻璃槽口 / glazing rebate	30mm
开启隔热条宽 / Open the insulation strip width	35.3mm
用料 / Materials used	9.37Kg/m <sup>2</sup>
主要特点 / main features	采光通透,安全防护,极简

# T-C128· LIFTING WINDOW

## T-C128·提升窗



### 产品外观 / Product appearance

外观 / Appearance : 扇料可视面宽度30mm      标配选配 / Optional : 重型挂钩, 中空隔条, 双提升或单提升

### 产品颜色 / Color

常规色



定制色



\*其他颜色自选/Other colors are optional.

### 产品参数 / Product parameters

型材厚度 / Profile Thickness	6063-T5原生铝 (可选T6) 型材壁厚1.78mm
框宽 / Box Width	128mm
单扇扇宽 / Single Fan Width	400mm-1500mm (单扇面积不大于3m <sup>2</sup> )
总体扇高 / Total Fan Height	<2600mm (或者单扇重量≤60公斤)
玻璃配置 / Glass Configuration	5mm+15A+5mm

### 五金配件 / Hardware accessories

五金标配 / Hardware Configuration : 美国考德威尔AAMA认证高级提拉五金

### 产品性能 / Product Performance



水密性能  
Water Tightness  
Performance  
600pa-5级



气密性能  
Airtightness  
Performance  
1.8m<sup>3</sup> / (m<sup>3</sup>·h)-7级



隔音性能  
Sound Insulation  
Performance  
35dB-4级



保温性能  
Thermal Insulating  
Property  
2.5W / (m<sup>2</sup>·K)-5级



抗风压性能  
Wind Pressure Resistance  
Performance  
4.8kPa-8级

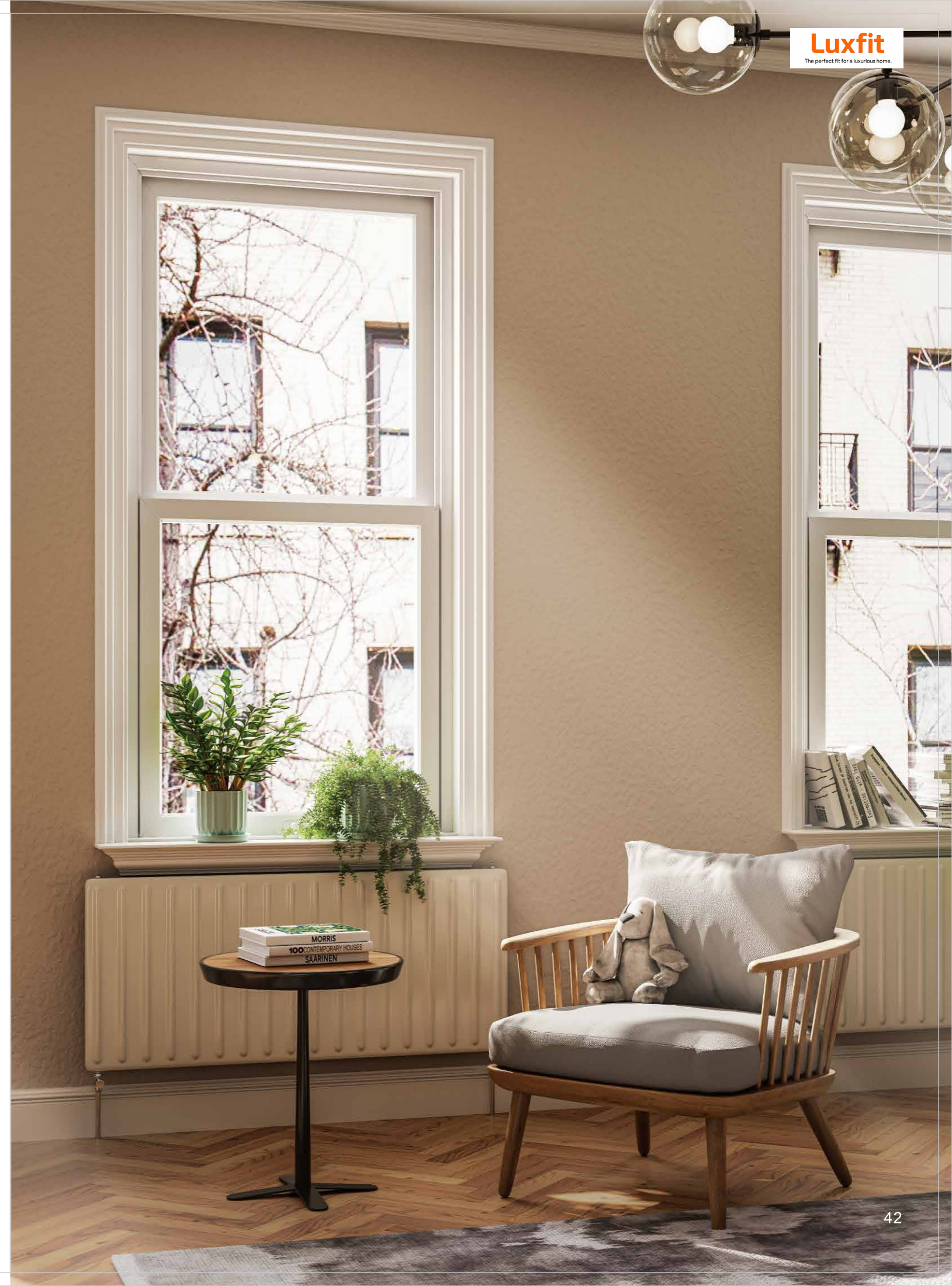

# SUNROOM SERIES · FULLY CUSTOMIZED SUNROOM

## 阳光房系列 · 全定制阳光房

### 产品外观 / Product appearance

外观 / Appearance: 扇料可视面宽度58-140mm 适用场景 / Apply to: 按需求定制

### 产品颜色 / Color

常规色

肌肤黑 肌肤白

定制色

哑光银灰 砂纹黑 砂纹灰 香槟金

\*其他颜色自选/Other colors are optional.

### 产品参数 / Product parameters

型材厚度 / Profile Thickness	6063-T5原生铝 壁厚1.3mm
执手 / Handle	德国HOPPE
铰链 / Hinge	Stanford承重铰链
选配纱网 / Optional Flyscreen	80/11目(孔径2.0mm)防剪防盗碳钢级
玻璃配置 / Glass Configuration	(5mm+16A+5mm/5MM+24A+5mm) 双玻/夹胶玻璃



## RAILING SERIES · OUTDOOR STAINLESS STEEL GUARDRAIL

护栏系列·室外不锈钢护栏

### 产品参数 / Product parameters

玻璃栏杆 / Glass railing	1200mmH
材质 / Material	304不锈钢
表面处理 / Finish	缎面/抛光/金色
玻璃适配 / Glass adaptation	适用于8~12mm厚玻璃



### 玻璃夹 / Glass clamp



## RAILING SERIES · OUTDOOR GLASS GUARDRAIL

护栏系列·室外玻璃护栏

### 产品参数 / Product parameters

高度 / Height	1200mmH
材质 / Material	304/316不锈钢
表面处理 / Finish	缎面/抛光/黑色/金色
玻璃适配 / Glass adaptation	适用于8~13.52mm厚玻璃

### 栏杆 / Handrail



### 插销 / Plug



# RAILING SERIES · OUTDOOR GUARDRAIL

## 护栏系列·室外护栏

### 产品参数 / Product parameters

材质 / Material	304/316不锈钢
表面处理 / Finish	缎面/抛光/黑色/金色
玻璃适配 / Glass adaptation	适用于Φ38/42/50.8mm扶手和8~13.52mm厚玻璃

### 玻璃夹 / Glass clamp



### 产品参数 / Product parameters

高度 / Height	1200mmH
材质 / Material	304/316不锈钢
表面处理 / Finish	缎面/抛光/黑色/金色
规格 / Specs	Φ38/42/50.8mm 立柱配 Φ8~12mm 杆

### 玻璃夹 / Glass clamp



# 用优雅的偏轴门 重新定义你的入口

## RFM Series - Entry Door

### RFM 系列-入户门

通过我们精心制作的偏轴门, 进入优雅和创新的新维度。这些门将现代美学与无与伦比的功能完美融合, 不仅仅是一个入口--它们是精致和设计的宣言。

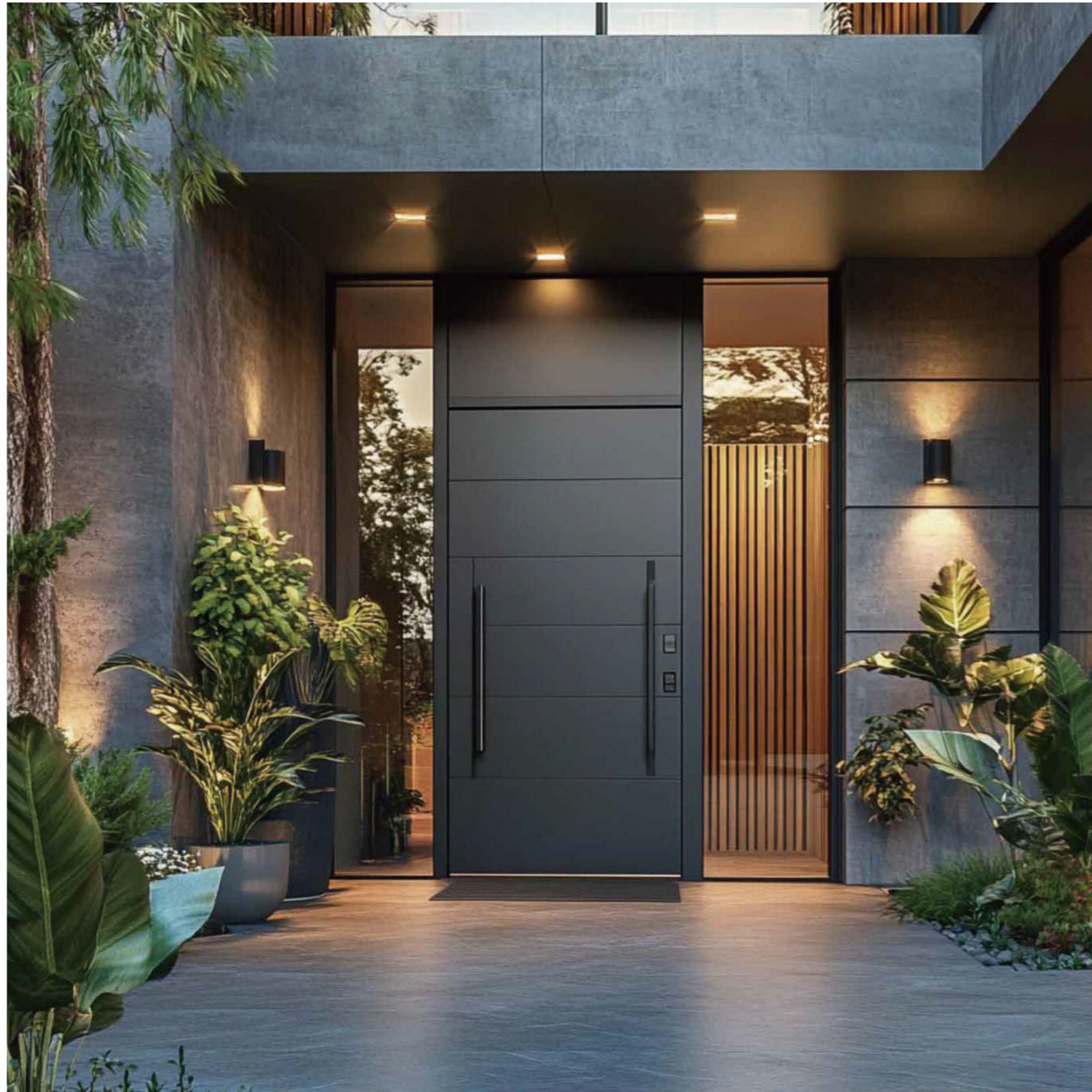

## 铝制入户门

### 配置 / Configuration

材质: 6063-T5铝合金	门类型: 定制
颜色饰面: 油漆	尺寸: 定制
安全功能: 防盗锁/加固框架	玻璃选项: 是

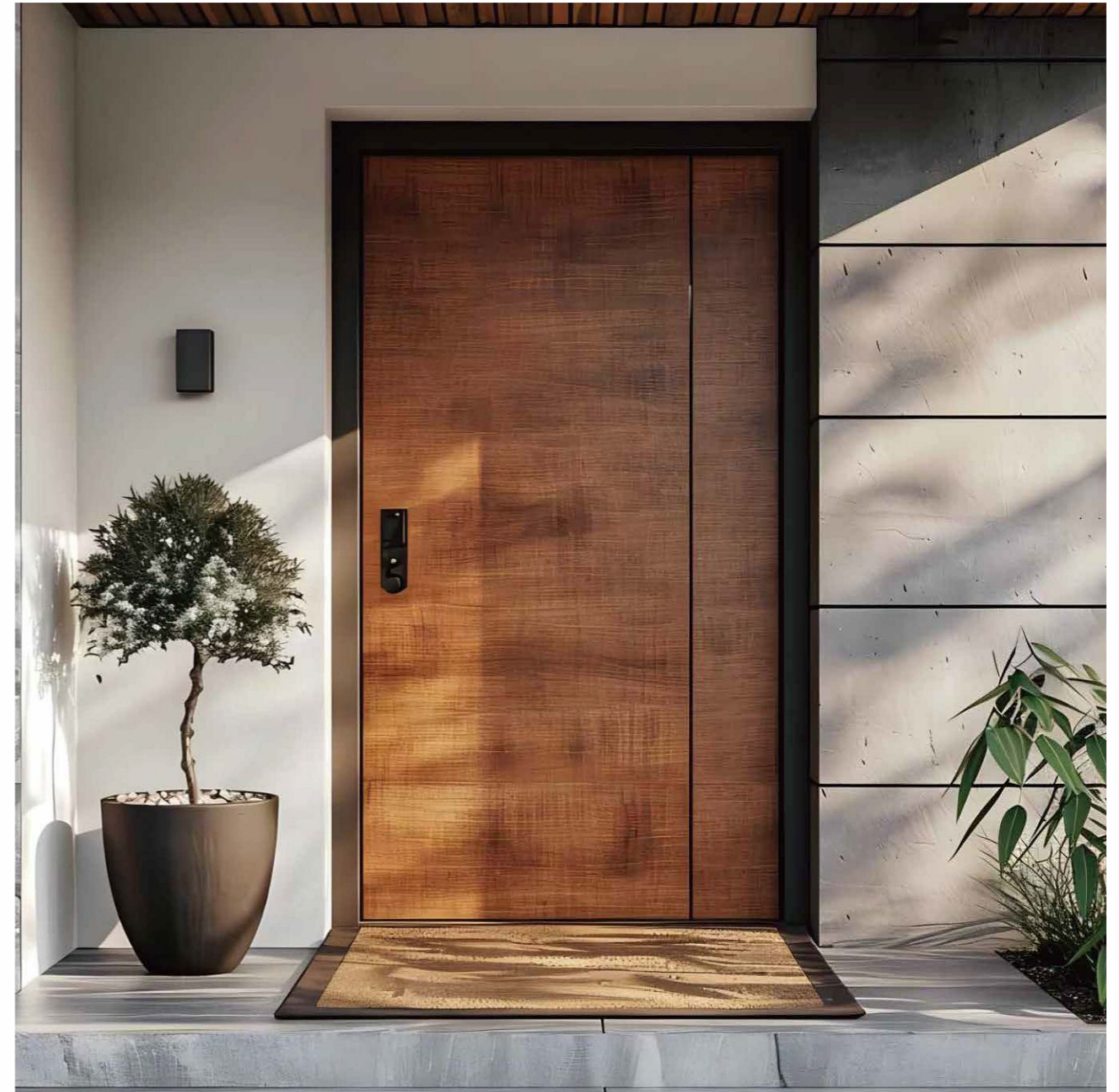

## 铝制木质入户门

### 配置 / Configuration

材质: 6063-T5铝合金	门类型: 定制
颜色饰面: 自然	尺寸: 定制
安全功能: 防盗锁/加固框架	玻璃选项: 是

## RFM 系列-入户门门型选择

### 常规造型门款式

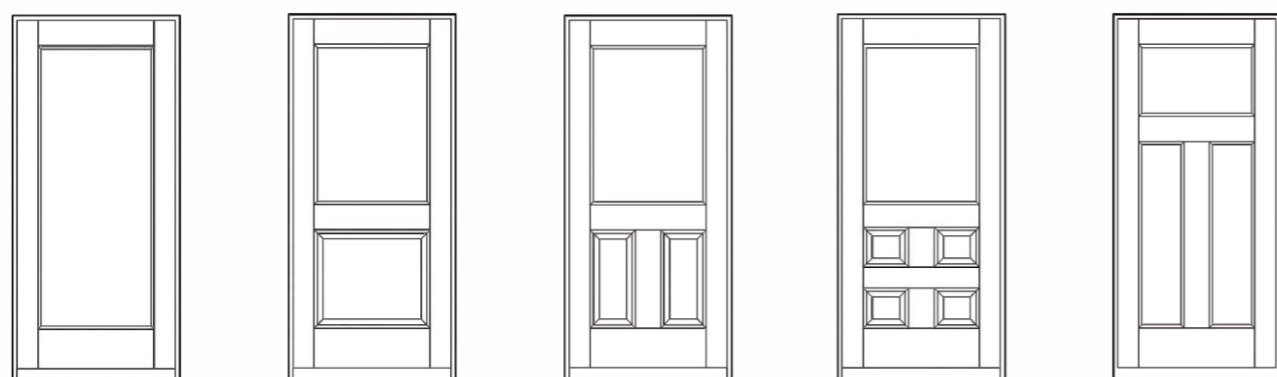

RFM01

RFM02

RFM03

RFM04

RFM05

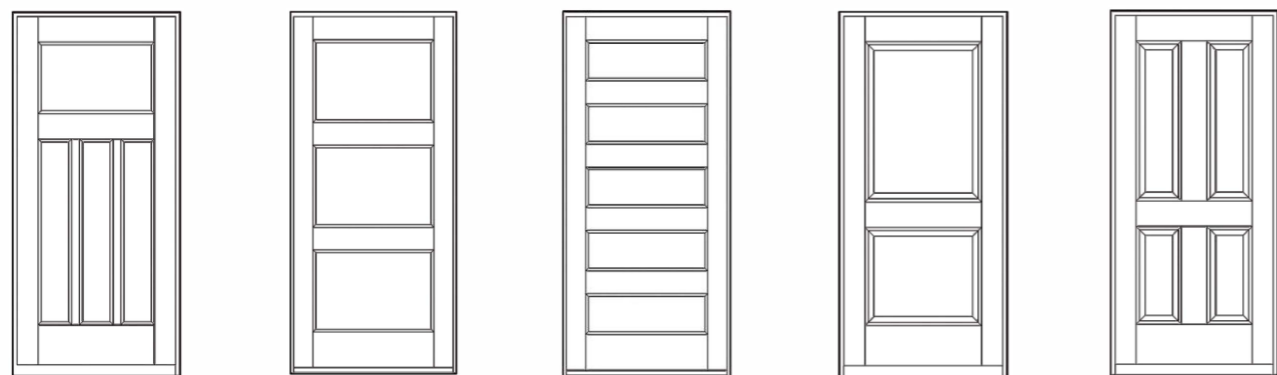

RFM06

RFM07

RFM08

RFM09

RFM10

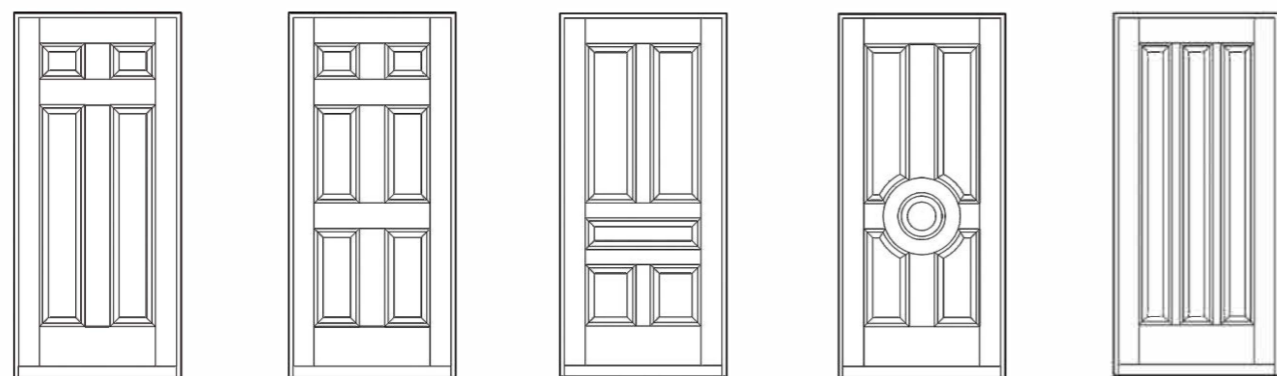

RFM11

RFM12

RFM13

RFM14

RFM15

### 带玻璃造型门款式

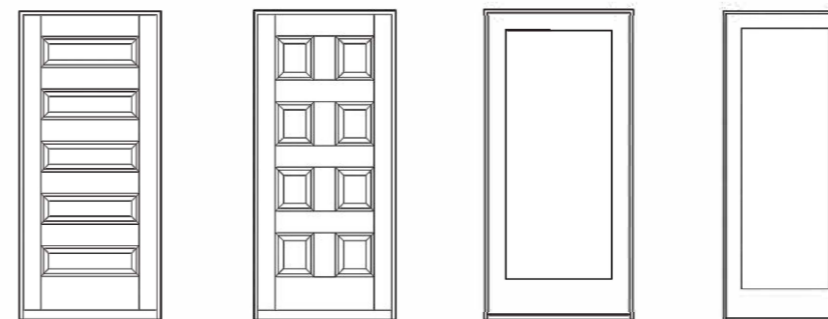

RFM16

RFM17

RFM18

RFM19

### 双开造型门款式

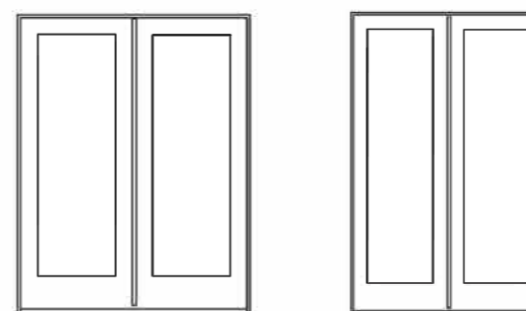

RFM20

RFM21

### 双开造型门款式

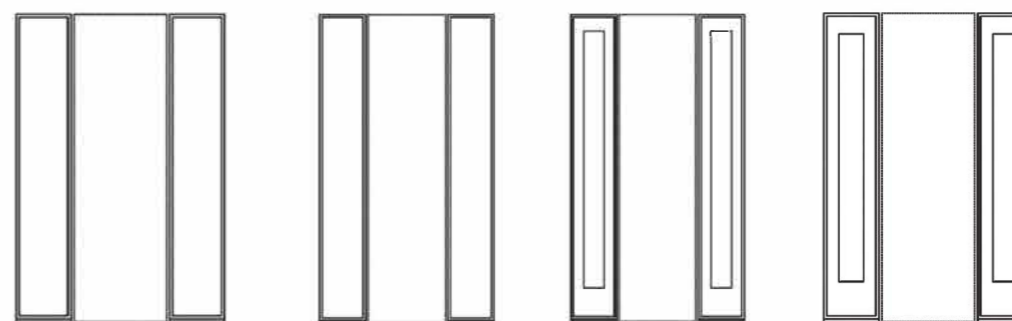

RFM22

RFM23

RFM24

RFM25

# CKM Series - Garage Door

## CKM 系列-车库门

### 钢化玻璃加强筋透视门

#### 配置 / Configuration

材质: 6063-T5原铝涂层	材料厚度: 铝型材1.4MM.带3mm加强筋, 5mm钢化玻璃
颜色: 乳白色、黑色	面板总厚度: 40mm
优点: 耐腐蚀、耐高温、韧性强	铰链处加厚厚度: 2.6mm
生产流程: 切割、拼接、组装	

\*为确保铰链安装牢固, 将在分段门板底部提供橡胶密封件。



### 铝合金拼接车库门

#### 配置 / Configuration

材质: 6063-T5原铝, 涂层	材料厚度: 1.4mm
优点: 耐腐蚀、耐高温、韧性强	面板总厚度: 40mm
生产流程: 切割、拼接、组装	铰链处加厚厚度: 2.6mm

\*为确保铰链安装牢固, 将在分段门板底部提供橡胶密封件。



# CKM Series - Garage Door

## CKM 系列-车库门

### 纯平绒面发泡车库门

门板采用欧洲高水准的优质大型车库门流水线生产线,聚集了行业顶尖的技术专家,通过几年时间深耕细作,笃行致远,拥有世界上最环保的发泡技术。

门板填充发泡密度高达50Ka/m<sup>±2</sup>,其闭孔率99%,保温隔热性能好,整体强度高,稳定性足以满足25-30年使用寿命。

卓越的设计令人信赖的好品质,为高端车库门前景创造了无限可能,成功的将家用车库门工艺提高到了一个新的高度,打造出世界顶级品质的高端家用车库门。

#### 配置/ Configuration



##### 镜面板

镜面板的优点是,污垢和水分容易滑落,特别适用于现代风



##### 木皮纹

这经典浮雕表面为您带来独具的原木粗线条视觉



##### 小波纹

这种波纹状表面富有立体感效果,并伴有规则的明暗变化风格的建筑



##### 铝镁锰合金板

与钢板比较,铝镁锰合金板更富有装饰性,使得装饰的表面更加高雅新颖

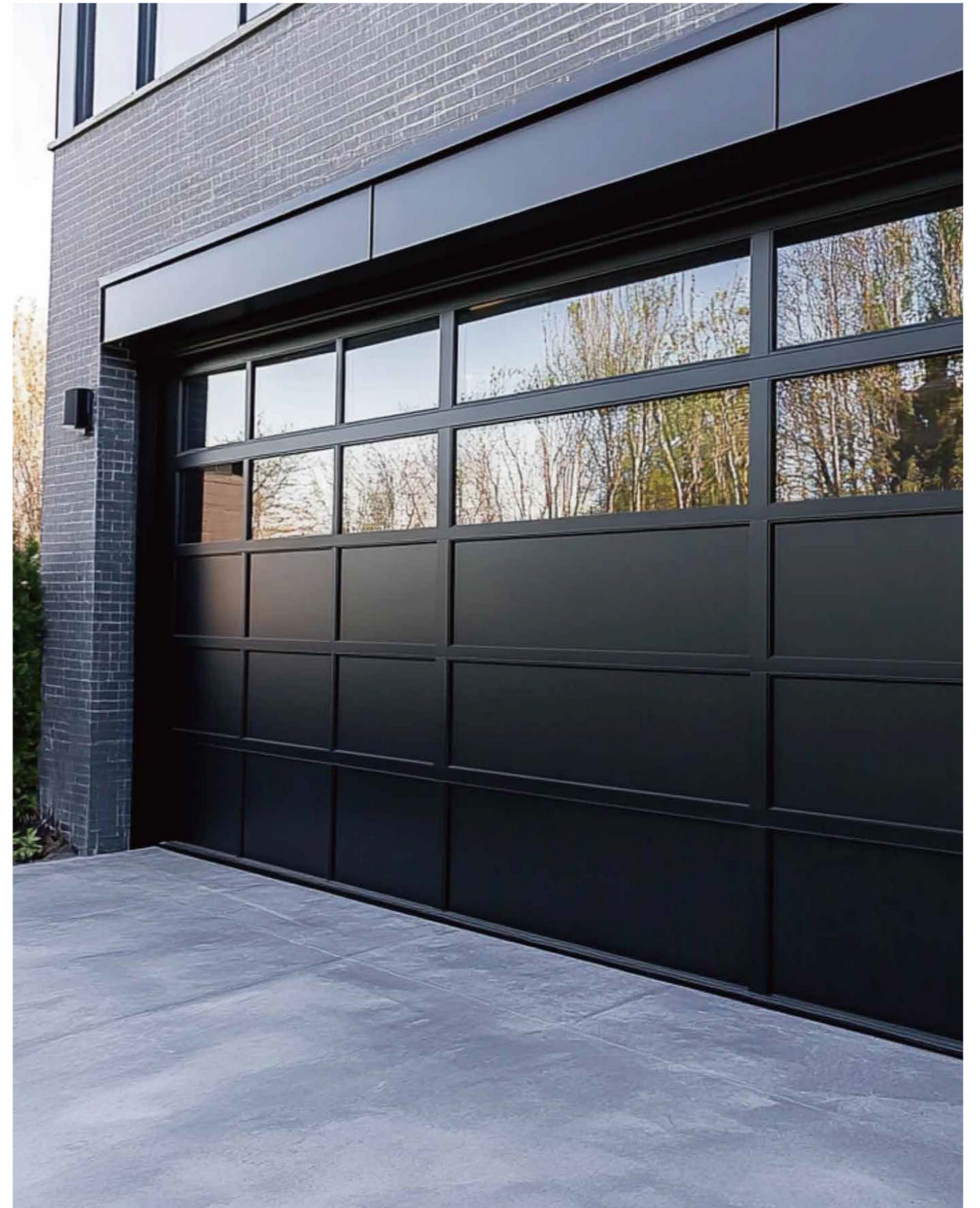

# CKM Series - Garage Door

## CKM 系列-车库门-配件

### 车库门可选视窗 / Garage door optional window

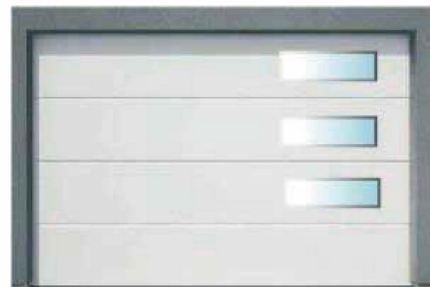

长方形铝合金窗

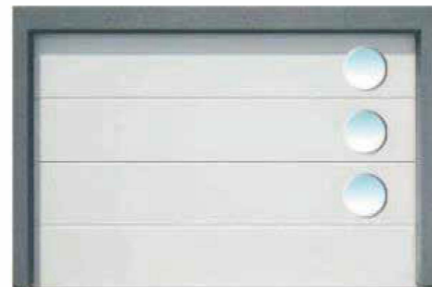

圆形铝合金窗

### / Hardware



#### 精巧的扭簧平衡系统

分节提升车库门扭簧系统的最大特点,即使在苛刻的环境下频繁使用,依然确保您的车库门宁静、顺畅、平稳运行。扭簧两端带有专利的一体式扭簧安全保护装置。一旦扭簧发生断裂,扭簧安全保护装置会立刻将门轴卡住,避免大门发生坠落危险。



#### 超静音运行

让门板运行更加安全采用Z6200工业级轴承,表面包覆N-66增强尼龙,超静音、抗耐磨,高温不变形,-40°低温不脆裂,坚固的滚轮支架以及安全的侧部轨道,让车库门摆脱脱轨的危险。即使大门打开平铺在天花板下方时,也非常安全。



#### 隐形防夹手, 断桥接口

门板内外及合页部位皆有防夹设计。车库门独特的门板结构,消除了门板与门板之间,以及合页处的缝隙,避免了夹手的危险。断桥接口隔热、防寒、防雷电。为保障美观度和舒适性,在镀锌表面基础上再进行酸洗磷化烤漆处理。

### 车库门可选视窗 / Garage door optional window



#### 加厚的门板端盖

形状与门板截面一致,美观、坚固、耐用。



#### 超静音可调节边铰链

即便车库墙面凹凸不平,也很容易保障安装精度,内置通长式耐磨尼龙轴套,终身免维护。



#### 高性能底部密封胶条

采用最新的三元乙丙材质低温不脆断,高温无龟裂达到长期高效密封。



#### 专用提升门体可调支架

专用提升门体可调支架,钢质结构巧妙的与底部铝型材结合可承载超大型门体,可实现双向调节门体高低。

# CERTIFICATION

## 资质认证

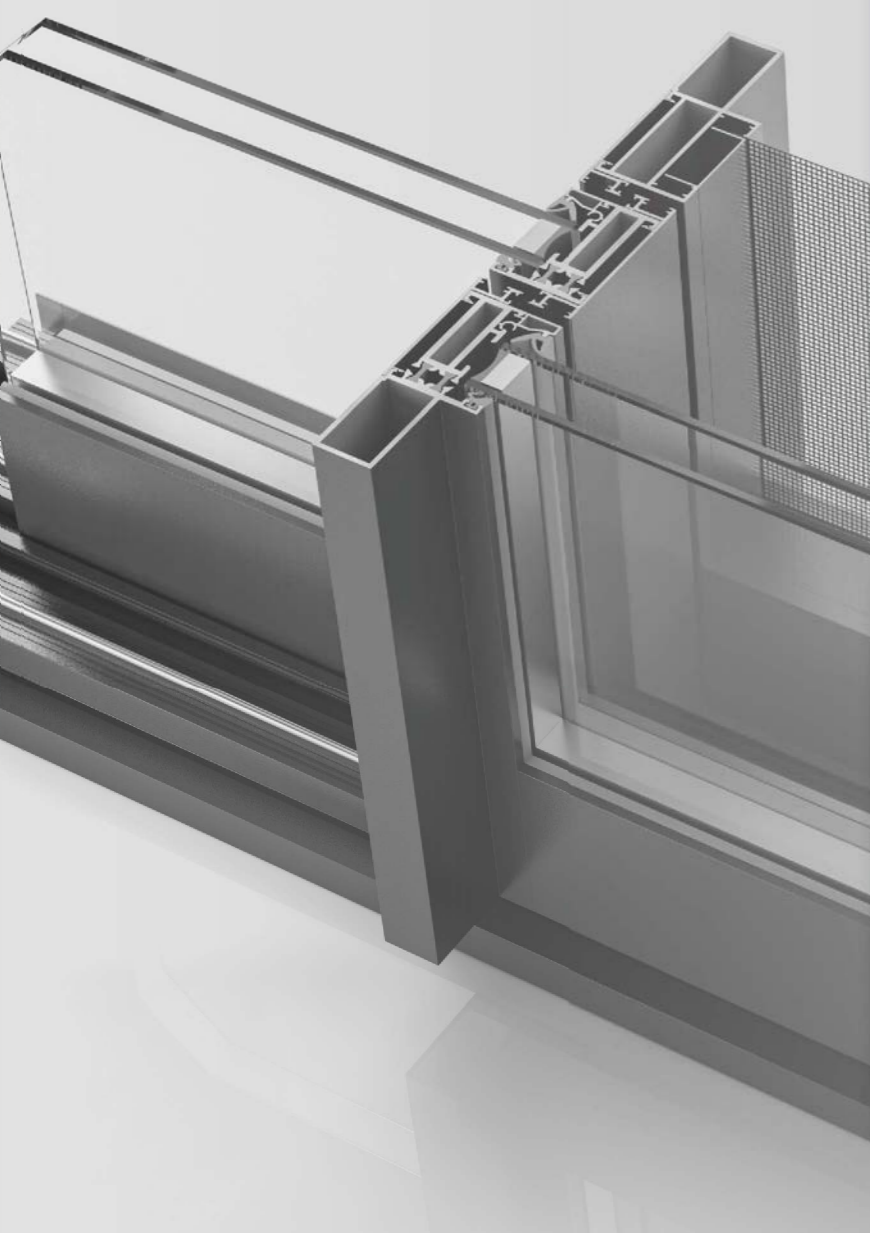

**intertek** **IAS**

### GUANGDONG PA WINDOWS & DOORS CO., LTD

## TEST REPORT

SCORE OF WORK  
WINDOWS AND DOORS

REPORT NUMBER  
340730932C-011

ISSUE DATE  
2023/12

PAGES  
18

Intertek Testing Services (Shenzhen) Ltd. Guangzhou Branch

Zertifikat / Certificate

Zertifizierung / Certificate No.: 220105424610-1-7

Beschläge für Holzbeschlebe Fenster und Fensterläden  
Hardware for lift and tilt windows and balcony door

Produkt: **SIEMENS** PENTAL HTS 150, 200, 250, 300, 350 COMPACT  
Gewicht: 400 kg

Systeme mit integrierender Beschlagsaufnahme  
Systeme mit integrierender Beschlagsaufnahme

Hersteller: **SIEMENS** ALU-KÜ Beschlag- und Lösungstechnik  
Produktname: **SIEMENS** ALU-KÜ Werk Hardware

ift

**CSA GROUP**

### Certificate of Compliance

Certificate: W020113 Master Contract: 40835

Project: W020113 Date Issued: 2023-11-16

Issued For: Guangdong PA Windows Co., Limited  
No. 23, Shuangong South Rd, Shuangong Industrial Area, Shuangong, Zhongshan, Guangdong, China

Attention: Yong shenghui

The products listed below are eligible to bear the CSA Mark shown with adjacent indicators 'C' and 'US' for Canada and US or with adjacent indicator 'US' for US only or without either indicator for Canada only.

Based by: Shirley Tang  
Shirley Tang

**CSA** **US**

CLASSIFICATION: CLASS - E-WINDOW SLIDING PRODUCTS AND MATERIALS: Windows (Non-Insulated Headed)  
CLASS - E-WINDOW SLIDING SYSTEMS AND STRUCTURES: Windows in the CLASS E-WINDOW Headed

Material	Primary product designation	Positive Strength (%)	Negative Strength (%)	Wear Resistance (%)	Canadian Air Infiltration

**NFRC Product Certificate of Authorization**

Manufacturer: Foshan Xiankuan Doors and Windows Co., Ltd  
Street: Shuangong North Road  
City/State/Zip: Foshan, Guangdong 528225

Product Series: XUBAO Dual Action Window  
Product Type: DATT

Simulation Lab: SFTL Test Lab: TPTL  
Site Report #: NRC0-21714 Test Report #: NRC0-21739  
Site Report Date: 05/14/2024 Test Date: 03/07/2024  
Revised Date: 05/14/2024 Revised Date: 03/07/2024  
Auth. Ratings: U-Factor, SHGC, VT, CR Test Method: NFRC 100  
Procedural Year: 2020 Procedural Year: 2020

Initial Certification Date: 05/13/2024  
Re-Certification Date: 05/07/2029  
Expiration Date: 05/07/2029

CPD Product Line Number: FSC-48-2  
Product Number Range: 0001-0001 to 0076-0001

Comments:  
I hereby certify that all requirements for NFRC Certification Authorization have been met and that the above information is true and correct, to the best of my knowledge.

Authorized US Signature: *[Signature]*

**STANDARDSMARK LICENCE** **SAI GLOBAL**

Intertek SAI Global hereby grants:  
**Guangdong PA Windows & Doors Co., LTD**  
No. 23, Shuangong South Rd, Shuangong Industrial Area, Zhongshan, Guangdong, China

Standard Mark Licence

Manufactured to: AS 2047-2014 - Windows and external glass doors for balustrade - This is certified on and sets the standard on

Intertek SAI Global hereby grants:  
**Guangdong PA Windows & Doors Co., LTD**  
No. 23, Shuangong South Rd, Shuangong Industrial Area, Zhongshan, Guangdong, China

Standard Mark Licence

Manufactured to: AS 2047-2014 - Windows and external glass doors for balustrade - This is certified on and sets the standard on

Intertek SAI Global hereby grants:  
**Guangdong PA Windows & Doors Co., LTD**  
No. 23, Shuangong South Rd, Shuangong Industrial Area, Zhongshan, Guangdong, China

Standard Mark Licence

Zhejiang Certification Co., Ltd.

### CERTIFICATE OF CONFORMITY OF ENVIRONMENTAL MANAGEMENT SYSTEM CERTIFICATION

GUANGDONG BAISHAN HOUSE AND HOME CO., LTD.

GB/T 24001-2016/ISO14001:2015 Standard

THE RELATIVE MANAGEMENT ACTIVITIES OF PROCESSING AND SALE OF KITCHEN CABINETS AND WAREHOUSE

IAF CNAS

**MA** **SGS** **CNAS**

### 检验报告 TEST REPORT

报告编号 (Report ID): 2405135102

产品名称: 三元乙丙门底密封胶条

规格型号: /

委托单位: 佛山市宝高铝门窗配件有限公司

南德认证检测(中国)有限公司

**TTA** **MA** **SGS** **CNAS**

### 检验报告 Test Report

产品名称: 双点锁

型号规格: HQ2410

委托单位: 佛山市宝高铝门窗配件有限公司

生产单位: 佛山市宝高铝门窗配件有限公司

检验类别: 委托检验

签发日期: 2023年07月24日

佛山市质量监督检测中心  
Foshan Supervision Testing Center of Quality and Metrology  
国家铝型材及门窗制品质量检测中心(广东)  
National Quality Inspection & Testing Center for Aluminum Profiles, Windows and Door Products (Guangdong)

# GLOBAL PARTNERS

合作伙伴



**blum** 百隆

**Jowat** 月交王  
Adhesives

**NUOMI** 诺米

**酷太** COOKTIME  
厨房收纳系统

**YALIS** 雅丽斯®  
极简空间艺术门锁

**SIEGENIA**  
brings spaces to life

**Hettich**

**悍高** HIGOLD

**SALICE**

**DTC** 东泰  
国际品质标杆

**HOPO**®  
好博窗控技术

**Roto**  
Window & Door  
Technology

**HOMAG**

**opk** 欧派克  
绿色欧派克·滑动门系统专家

**Yongmao**

**SHERWIN-WILLIAMS**

**BOGO** 宝高  
用心做好门窗五金

**KIN LONG**  
For Better Living

**Unihopper** 库博®

**ilin** 宜琳照明  
ighting

**汇龙涂料**  
专业 成就 价值

**HUALI** 华立股份  
股票代码:603038.SH

**XYG**  
信義玻璃

**中旗新材**  
SINOSTONE  
-- 001212 --

# Luxfit

YOUR ONE STOP SOLUTION

